

**An Environmentally Safe Alternative.
Engineered Terminations. Fast, Easy To Install.**

Updated October 2011

PolyPro®

Venting system for condensing gas/oil appliances.

Listed to ULC-S636.



DuraVent
Member of  M&G Group



Being Green, Being Responsible.

M&G DuraVent looks for feasible ways of doing business in an ecologically sound way.

In manufacturing we use water based paints. Our reverse osmosis system recycles 90% of the water used in the paint line.

We buy recycled metals for all our products when available, and recycle waste metals. Factory skylights reduces heavy load needs for electric lighting during daylight hours.

In the office, paperless invoicing is now standard. Paperless communications to customers are sent via electronic newsletters or email, and we recycle office paper waste.

Kaizen (Japanese for "improvement") refers to the practice of focusing on continuous improvement in manufacturing activities. By improving standardized activities and processes, Kaizen aims to eliminate waste. Since 1998, DuraVent has reduced manufacturing waste in its plant by 30% through Kaizen practices.

DuraVent is a member of the US Green Building Council,(USGBC) a non-profit organization dedicated to sustainable building design and construction, and developers of the LEED building rating system.

PolyPro is one of M&G DuraVent's GreenVent® line of products.





PolyPro[®]

GreenVent

PolyPro is superior in performance and easier to install than PVC or CPVC pipe, which were designed for irrigation, not venting. PolyPro has been successfully venting appliances in Europe for over 15 years.

Tested and listed to the ULC S636 standard in Canada.

- Can be cut to desired length.
- No messy solvents to work with.
- No worrying whether it is warm enough to glue pieces together.
- No ugly terminations.
- Gasketed connections with a precise, tight seal.
- Terminations remain icicle free in freezing weather.
- Tight seal at every joint...expands and contracts with weather and temperature changes, so there is no flexing or cracking in the venting.
- Interior of 90° elbows are 88° to prevent standing condensation.
- Higher sustained operating temperatures than PVC/CPVC.
- Lightweight and easy to install.
- Gasketed connections allow for removal and replacement of components.
- Corrosion resistant.
- 100% recyclable.
- No leaching or off-gassing of heavy metals or carcinogens. Releases only oxygen and carbon dioxide when burned.
- Resistant to aromatic hydrocarbons generated by gas combustion.
- Resistant to acids and bases.
- No chlorides in PolyPro, unlike PVC/CPVC.

Engineered Excellence[®]

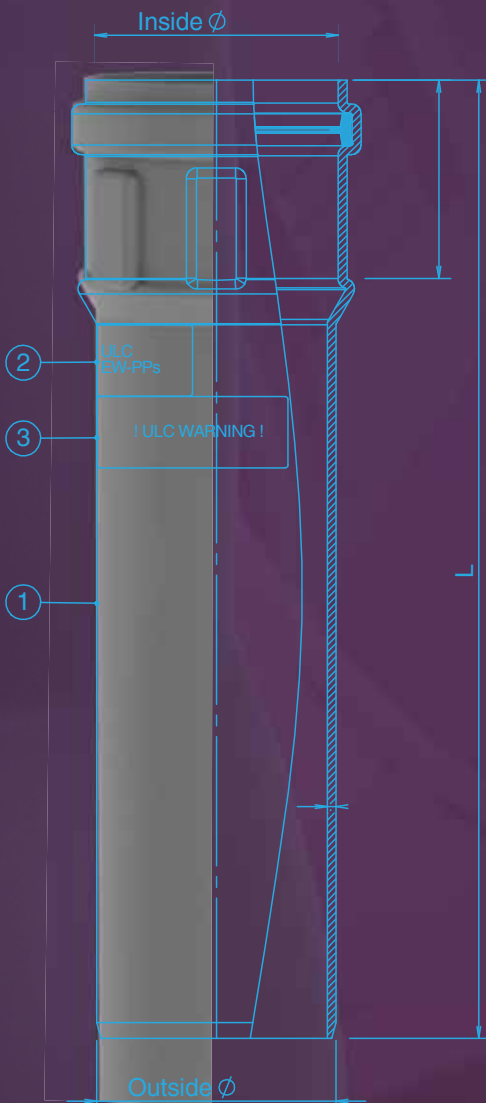

DuraVent

Engineered Excellence®



M&G DuraVent is dedicated to one thing...focusing on the design and manufacture of venting products. As experts in this industry, our team is passionate about creating innovative, quality products. We invest in equipment with the latest technology to develop and test venting products that are engineered to one standard, excellence.

All measuring equipment is calibrated to the same levels as used by testing agencies, and are compliant with ISO 17025, the test laboratory standard.

Wind Tunnel Laboratory

The wind tunnel lab allows us to gather precise data with 270 degrees of measurement on terminations. All data is analyzed for product performance under rigorous conditions before going to market.

Appliance Testing

M&G DuraVent offers appliance testing for OEM's.

Rain Testing

M&G labs test the vapor/moisture barrier of products by subjecting them to extreme rain and wind conditions. These tests are compliant with both the US and Canadian requirements, as well as the stringent European standards.

Climate Testing

M&G labs have developed a patented ice testing system in the climate room. Tests run to -4° F (-20°C). PolyPro terminations are engineered to remain icicle free.

Commercial and OEM Product Development

M&G DuraVent engineers are expertly skilled to develop venting components to OEM specs. To satisfy specific venting requirements, DuraVent has the experience to provide custom design, prototyping and testing of vent systems and components engineered to the demands of specific appliances.



Terminations DuraVent's PolyPro terminations are lab tested to handle harsh weather and remain icicle free in freezing temperatures. Air circulation and weather conditions like rain, wind and ice have the potential to reduce the efficiency of a units performance and the operation of it's venting system. M&G DuraVent has designed its terminations for a tight, leak-free system that does not allow icicle formations.

PolyPro is available for solutions requiring single-wall, concentric, manifold and other engineered uses. Inquire to find out more. 800-835-4429.

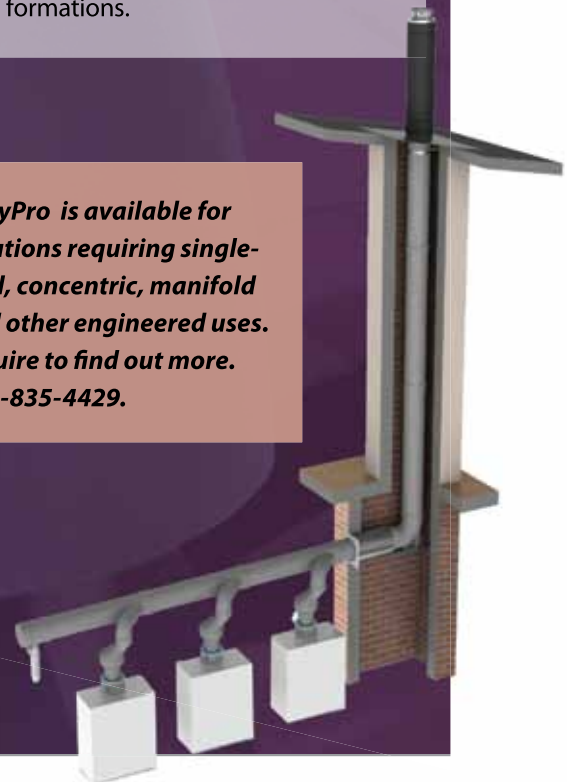

Environmental Advantages

PolyPro and PVC/CPVC

PVC pipes are commonly used for venting water heaters, condensing boilers and warm air furnaces, yet PVC was never designed for such use. An environmentally safe and engineered alternative is PolyPro, for condensing gas appliances. Engineered for venting, it is 100% recyclable, and contains no toxic or carcinogenic materials, chlorides, or heavy metals. PolyPro does not release hazardous gases during combustion, and has been used safely throughout Europe for over fifteen years. Polypropylene has a higher operating temperature limit of 248°F/120°C (PVC is 149°F/65°C max and CPVC is 194°F/90°C). PolyPro is engineered with a corrosion-free, condensation management system.

PolyPro complies with LEED® credit IEQc4.1 on VOC limits.



'LEED' and USGBC logo is a trademark owned by the U.S. Green Building Council and is used by permission.

Planning Your Installation

Check with your appliance manufacturer or look in the appliance installation instructions to verify that M&G DuraVent's PolyPro vent is allowed for use with your appliance. PolyPro is stocked in nominal diameters of 2" (60mm), 3" (80mm) and 4" (100mm). Allow for a 2" overlap when connecting pipe together. Refer to the installation instructions on DuraVent's website: www.duravent.com.

A Locking Band is required at every exhaust vent joint, and optional for the air inlet vent joints. The Locking Band meets ULC S636 requirements for securing the joint. In addition, supporting Wall Straps are required at least every 10 feet (3 meters) for vertical vent pipe sections, and horizontal or sloped sections of vent pipe require one supporting Wall Strap for each pipe section.

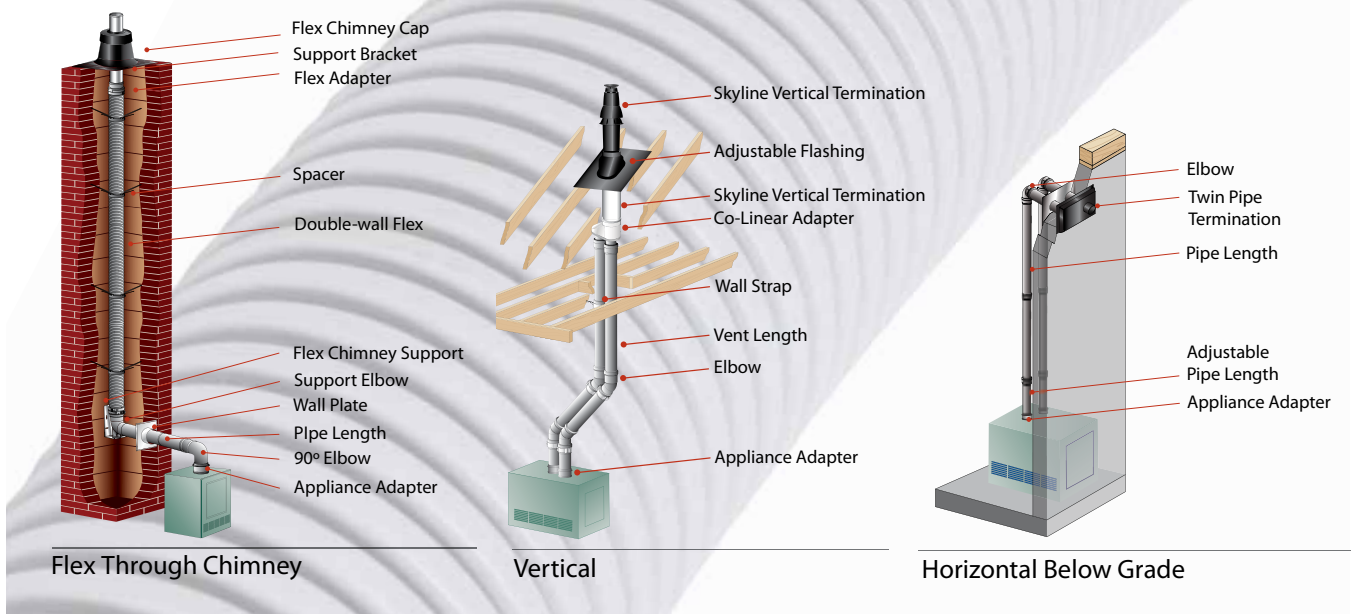

DuraVent

PolyPro® Single Wall and Flex

Specifications

Applications

PolyPro is a polypropylene vent pipe for use with ANSI Category II and IV gas burning appliances, including tankless and storage water heaters, high-efficiency water heaters, condensing boilers and warm air furnaces. Poly Pro is listed by Intertek to the ULC S636 standard in Canada and is rated as a Class IIA, IIB and IIC vent system suitable for exhaust temperatures up to 230°F / 110°C, and a maximum positive pressure of 8 in-w.c.

Clearances

0" clearance to combustibles for exhaust temperatures up to 194°F / 90°C, and 0" clearance for vertical installations up to exhaust temperatures of 230°F / 110°C and ¼" / 6mm clearance to combustibles for horizontal installations at exhaust temperatures up to 230°F / 110°C. PolyPro concentric vent system components, including concentric Horizontal Termination and Vertical Termination, are listed at 0" clearance to combustibles for exhaust temperatures up to 230°F / 110°C.

Materials and Construction

Rigid pipe constructed of 2.2mm (minimum) thick polypropylene. Flex is double-wall polypropylene. EPDM or Viton gaskets.

Diameters

2" (60mm), 3" (80mm),
4" (100mm), 5" (125mm)

Listings

Intertek / Warnock-Hersey listed to ULC-S636 Listed as a Class IIA, IIB, and IIC vent system

Warranty

10 years

ISO 9001 Registered by GasTec



ULC S636 Listed Vent System

PolyPro is approved by the Massachusetts Plumbers Board. Approval code G1-0811-42.



Single-Wall Venting System

Single-Wall Pipe

Use to vent condensing appliances. 2" of overlap at the joint. Listed to ULC-S636.



SIZE	12"	36"	72"
2"	2PPS-12	2PPS-36	2PPS-72
3"	3PPS-12	3PPS-36	3PPS-72
4"	4PPS-12	4PPS-36	4PPS-72

Adjustable Pipe

Use to add length to straight length of PolyPro pipe. Slips over standard single-wall pipe length. 4 1/2" of adjustment.

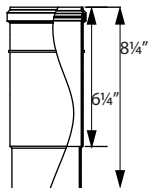

SIZE	STOCK #
2"	2PPS-AVL
3"	3PPS-AVL
4"	4PPS-AVL

Test Port

Use to test for proper appliance operation without penetrating or disconnecting the vent wall. Install immediately above the appliance.

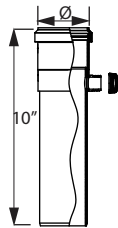

SIZE	STOCK #
2"	2PPS-TP
3"	3PPS-TP
4"	4PPS-TP

45° Elbow

Offsets obstructions as needed.

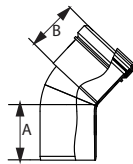

SIZE	STOCK #	A	B
2"	2PPS-E45	2 7/8"	2 11/16"
3"	3PPS-E45	2 7/8"	2 7/8"
4"	4PPS-E45	3"	2 1/2"

90° Elbow

Offsets obstructions as needed.

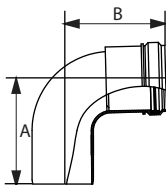

SIZE	STOCK #	A	B
2"	2PPS-E90	4"	4"
3"	3PPS-E90	4 5/16"	4 5/16"
4"	4PPS-E90	4 1/2"	4 1/2"

Condensate Drain

Use to properly manage corrosive condensates common with high efficiency gas appliances.

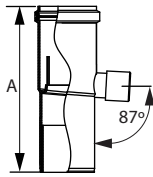

SIZE	STOCK #	HEIGHT
2"	2PPS-CD	7"
3"	3PPS-CD	7"
4"	4PPS-CD	7"

Tee with Cap

Use for a 90° offset or to combine connections from two or more appliances into a common vent.

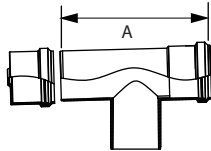

SIZE	STOCK #	A
2"	2PPS-T	7"
3"	3PPS-T	7 7/8"
4"	4PPS-T	8 11/16"

Tee with Drain Cap

Use instead of Tee Cap to manage condensates at the bottom of a vertical run.

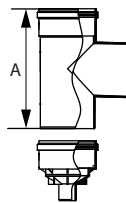

SIZE	STOCK #	A
2"	2PPS-TCD	7"
3"	3PPS-TCD	7 7/8"
4"	4PPS-TCD	8 11/16"

Reducer

Use to transition the vent system to a smaller diameter.

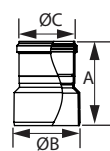

SIZE	STOCK #	A	B	C
3" - 2"	3PPS-R2	5"	3"	2"
4" - 3"	4PPS-R3	5"	4"	3"

Increaser

Use to transition the vent system to a larger diameter. Install in vertical orientation.

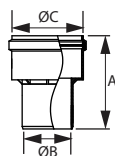

SIZE	STOCK #	A	B	C
2" - 3"	2PPS-X3	4 5/16"	2"	3"
3" - 4"	3PPS-X4	4 5/16"	3"	4"
4" - 5"	4PPS-X5	4 5/16"	4"	5"

Appliance Adapter, PVC to PolyPro

Use to connect rigid PolyPro pipe length to PVC/CPVC coupler, or appliance outlet. Must be used with Adapter Connector for flue gas.

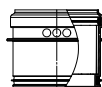

SIZE	STOCK #
2"	2PPS-AD
3"	3PPS-AD
4"	4PPS-AD

Adapter Connector

Use to secure PolyPro pipe to PVC/CPVC coupler or appliance outlet. Universal size for 2, 3 and 4 inch systems. M&G DuraVent requires it's use with flue gas applications, and recommend's it with air intake applications.



SIZE	STOCK #
2" - 4"	PPS-PAC

Wall Strap - polypropylene

Use to support for offsets, vertical and horizontal runs. Clicks in place. Anchor Bolt included. Supporting Wall Straps are required at least every 10 feet (3 meters) for vertical vent pipe sections, and horizontal or sloped sections of vent pipe require one supporting Wall Strap for each pipe section.

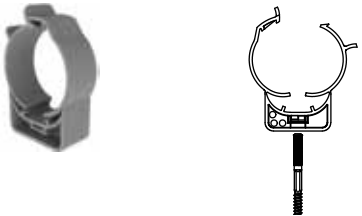

SIZE	STOCK #
2"	2PPS-WS
3"	3PPS-WS
4"	4PPS-WS

Locking Band

Use to secure two pieces of pipe together. Must be used with Wall Strap (above). See Locking Band kit for both. Required to comply with ULC-S636 listed installations.



SIZE	STOCK #
2"	2PPS-LB
3"	3PPS-LB
4"	4PPS-LB

Locking Band Kit

Use to secure two pieces of pipe together. Includes polypropylene style wall strap and locking band with bolt for a full system. Required to comply with ULC-S636 listed installations.



SIZE	STOCK #
2"	2PPS-LBK
3"	3PPS-LBK
4"	4PPS-LBK

Firestop Spacer

Use when penetrating floor levels. Two piece design for easier installation.



SIZE	STOCK #
2"	2PPS-FS
3"	3PPS-FS
4"	4PPS-FS

Flat Roof Flashing

Use to weather proof penetration of vent through the roof. For concentric and single wall pipe.



SIZE	STOCK #	A	B
2" x 4"	2PPS-FF	4"	13 3/4"
3" x 5"	3PPS-FF	5"	15 5/16"
4" x 6"	4PPS-FF	6"	17"

Adjustable Roof Flashing, 0/12 - 5/12 pitch

Use to weather proof penetration of vent through the roof. For concentric and single wall pipe. Made of aluminum. Adjusts from 0 - 25° (0/12 to 5/12).

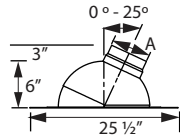

SIZE	STOCK #	A
2" x 4"	2PPS-F5	4"
3" x 5"	3PPS-F5	5"
4" x 6"	4PPS-F5	6"

Adjustable Roof Flashing, 5/12 - 12/12 pitch

Use to weather proof penetration of vent through the roof. For concentric and single wall pipe. Made of polypropylene. Adjusts from 25° to 45° (5/12 to 12/12). Black or terra-cotta. UV resistant.

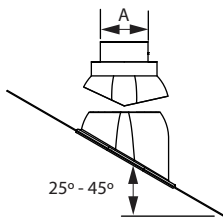
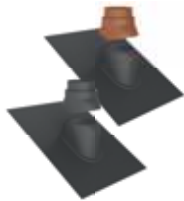

SIZE	BLACK	TERRA-COTTA	A
2" x 4"	2PPS-F12	2PPS-F12-TC	4"
3" x 5"	3PPS-F12	3PPS-F12-TC	5"
4" x 6"	4PPS-F12	4PPS-F12-TC	6"

Horizontal Termination Kit - Concentric

Use for concentric horizontal terminations. Includes 2 appliance adapters, white wall plate, white firestop, co-linear adapter. White, Termination with Bird Guard Screen. UV resistant.

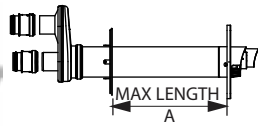

SIZE	STOCK #	A
2" x 4"	2PPS-HK	17"
3" x 5"	3PPS-HK	17"
4" x 6"	4PPS-HK	17"

Vertical Termination Cap Kit - Concentric

Use for concentric vertical terminations. Includes 2 appliance adapters, co-linear adapter. Black or terra-cotta cap. UV resistant.

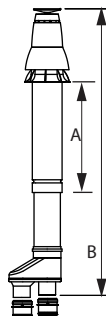

SIZE	BLACK CAP	TERRA-COTTA CAP	A	B
2" x 4"	2PPS-VK	2PPS-VK-TC	18"	50 1/4"
3" x 5"	3PPS-VK	3PPS-VK-TC	23"	53 1/4"
4" x 6"	4PPS-VK	4PPS-VK-TC	23"	68 1/4"

Twin Pipe Termination

Use to terminate horizontally with two single wall PolyPro pipes for intake and exhaust. Air intakes between the black metal Exterior plates. Black UV resistant polypropylene exhaust nozzle with Bird Guard Screen. Interior Wall Plate of paintable metal. 14" pipe lengths.

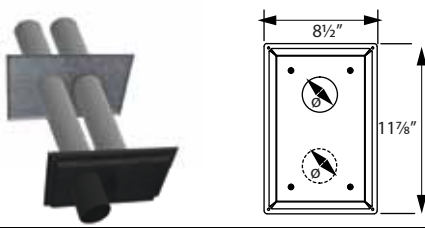

SIZE	STOCK #
2"	2PPS-HTP
3"	3PPS-HTP

Single Horizontal Termination

Use to terminate horizontal applications with PolyPro. Termination elbow and plate may be rotated. Termination Elbow is UV resistant black with Bird Guard Screen. Interior Wall Plate paintable metal, Exterior Wall Plate painted black. 14" pipe length.



SIZE	STOCK #
2"	2PPS-HST
3"	3PPS-HST

EPDM Replacement Gasket

Use as a replacement gasket for rigid PolyPro products. Pack of 12.



SIZE	STOCK #
2"	2PPS-GA
3"	3PPS-GA
4"	4PPS-GA

Viton Replacement Gasket for Condensing Oil Appliances

Use as a replacement gasket when using PolyPro products with condensing oil appliances. Pack of 12.



SIZE	STOCK #
2"	2PPS-GAV
3"	3PPS-GAV
4"	4PPS-GAV

Adapter Gasket

Use as a replacement gasket for the Appliance Adapter. For 3" and 4" use the EPDM Replacement Gasket. Pack of 12.



SIZE	STOCK #
2"	2PPS-GAA

Flex Venting System

Flex Chimney Lining Kit

Use for a vertical flex lining system. Includes black, UV resistant chimney cap, rigid flue vent, support bracket, 4 spacers (in 2", 3" & 4" kits), male and female flex adapters, support elbow, wall plate and appliance adapter. Flex sold separately.

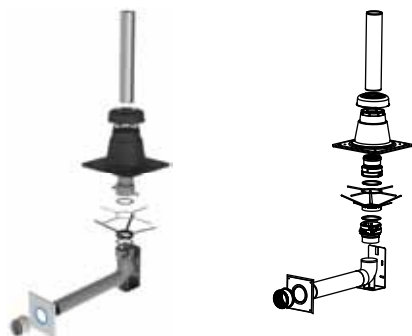

SIZE	STOCK #	SIZE	STOCK #
2"	2PPS-FK	4"	4PPS-FK
3"	3PPS-FK	5"	5PPS-FK

Flex Chimney Cap

Use to vertically terminate a flex system. Black, UV resistant chimney cap with rigid steel flue vent.

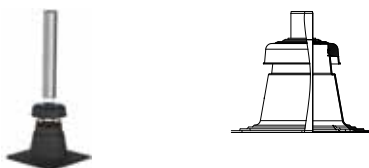

SIZE	STOCK #	SIZE	STOCK #
2"	2PPS-FCT	4"	4PPS-FCT
3"	3PPS-FCT	5"	5PPS-FCT

Flex Length

Use to line masonry chimneys that vent condensing appliances. Double-wall construction. Can be cut to precise length in the field. Available in 25, 35 or 50 foot lengths. 5" diameter flex comes in rolls of 98 feet only.



SIZE	25 FEET	35 FEET	50 FEET	82 FEET	98 FEET
2"	2PPS-FLEX25	2PPS-FLEX35	2PPS-FLEX50	-	-
3"	3PPS-FLEX25	3PPS-FLEX35	3PPS-FLEX50	-	-
4"	4PPS-FLEX25	4PPS-FLEX35	-	4PPS-FLEX	-
5"	-	-	-	-	5PPS-FLEX

Flex Male Adapter

Use to connect PolyPro rigid pipe to PolyPro flex at the base of the system. Flex gasket included.



SIZE	STOCK #	SIZE	STOCK #
2"	2PPS-FAM	4"	4PPS-FAM
3"	3PPS-FAM	5"	5PPS-FAM

Flex Female Adapter

Use to terminate PolyPro flex lining system back to a rigid system. Flex gasket included.



SIZE	STOCK #	SIZE	STOCK #
2"	2PPS-FAF	4"	4PPS-FAF
3"	3PPS-FAF	5"	5PPS-FAF

Flex Coupler Adapter

Use to tightly connect one length of PolyPro flex to another. Flex gasket included.



SIZE	STOCK #	SIZE	STOCK #
2"	2PPS-FAC	4"	4PPS-FAC
3"	3PPS-FAC	5"	5PPS-FAC

Support Bracket

Use to support PolyPro Flex from top of masonry chimney.

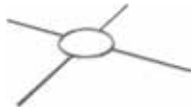

SIZE	STOCK #	SIZE	STOCK #
2"	2PPS-FSB	4"	4PPS-FSB
3"	3PPS-FSB	5"	5PPS-FSB

Spacer

Use to center PolyPro flex. Universal for all diameters. Simple installation and ratchet adjustment.



SIZE	STOCK #	SIZE	STOCK #
2"	2PPS-S	4"	4PPS-S
3"	3PPS-S		

Support Elbow, Extended

Use the extended support elbow to stabilize the vertical termination. Extended horizontal length can be trimmed to size. Includes supporting assembly and mounting channel.

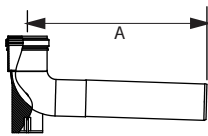

SIZE	STOCK #	A	SIZE	STOCK #	A
2"	2PPS-SE90X	21 1/16"	4"	4PPS-SE90X	22 7/16"
3"	3PPS-SE90X	22 1/4"	5"	5PPS-SE90X	24 7/16"

Flex Chimney Support

Use to support the Support Elbow inside a masonry chimney.

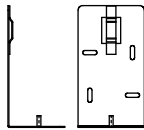

SIZE	STOCK #	SIZE	STOCK #
2"	2PPS-SUP	4"	4PPS-SUP
3"	3PPS-SUP	5"	5PPS-SUP

Wall Plate

Use to trim wall penetration. Aluminum. Can be painted.

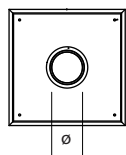

SIZE	STOCK #	SIZE	STOCK #
2"	2PPS-WP	4"	4PPS-WP
3"	3PPS-WP	5"	5PPS-WP

Viton Replacement Gasket, Flex

Use as a replacement gasket for PolyPro flex products.



SIZE	STOCK #	SIZE	STOCK #
2"	2PPS-GAF	4"	4PPS-GAF
3"	3PPS-GAF	5"	5PPS-GAF

Flex Puller

Use with the provided rope to guide PolyPro flex lengths down masonry chimney.



SIZE	STOCK #	SIZE	STOCK #
2"	2PPS-FP	4"	4PPS-FP
3"	3PPS-FP	5"	5PPS-FP

OEM Appliance Approvals of PolyPro

As of October 3 2011. Call for latest information.

OEM Boiler	Model	US	CA	Status	PolyPro	Concentric M&G	Flex
Allied engineering company	Intergas HSE-125 N/P	x	x	Certified with M&G	x	Supplied by OEM	x
Baxi marathon international	Luna HT 380	x	x	Certified with Polypro	x		
	Luna HT 1.33	x	x	Certified with Polypro	x		
	Luna HT 1.45	x	x	Certified with Polypro	x		
	Luna HT 1.65	x	x	Certified with Polypro	x		
	Luna HT 1.100	x	x	Certified with Polypro	x		
Burnham	Alpine 80/105	x	x	Certified with M&G	x	Supplied by OEM	
	Alpine 150/210	x	x	Certified with M&G	x	Supplied by OEM	
	Alpine 285/399/500	x	x	Certified with M&G	x	Supplied by OEM	
Camus	Dynamax 78/97/146/194/243 BTU	x	x	Certified with Polypro	x		
	Dynaforce 300/350/400/500/600/800	x	x	Certified with Polypro	x		
Heat Transfer Products	Mudcon	x	x	Certified with Polypro	x		x
	Elite	x	x	Certified with Polypro	x		x
IBC technologies	VFC 15-150	x	x	Certified with Polypro	x		
	VFC 45-225	x	x	Certified with Polypro	x		
	SL 80-399	x	x	Certified with Polypro	x		
Laars	Neotherm 80/105	x	x	Certified with Polypro	x		
	Neotherm 150/210	x	x	Certified with Polypro	x		
	Neotherm 285/399/500/600	x	x	Certified with Polypro	x		
	Neotherm 750/800	x	x	Certified with Polypro	x		
	Mascott II	x	x	Certified with Polypro	x		
Lochinvar	Knight 50/285	x	x	Certified with Polypro	x		x
	Knight XL 399/800	x	x	Certified with Polypro	x		x
Mestek	RBI Infinite Series	x	x	Certified with Polypro	x	Supplied by OEM	x
NY thermal	Trinity TI 100-200	x	x	Certified with Polypro	x		
	Trinity TI 400	x	x	Certified with Polypro	x		
	Trinity LX 150-200	x	x	Certified with Polypro	x		
	Trinity LX 400	x	x	Certified with Polypro	x		
	Trinity LX 800	x	x	Certified with Polypro	x		
Peerless boilers	Purefire 50/140	x	x	Certified with Polypro	x	Supplied by OEM	
	Purefire 210	x	x	Certified with Polypro	x	Supplied by OEM	
	Purefire 399	x	x	Certified with Polypro	x	Supplied by OEM	
	Pinnacle OIL	x	x	Certified with Polypro	x	Supplied by OEM	
QHT	Riva Plus Combi	x	x	Certified with Polypro	x	Supplied by OEM	
Triangle Tube	Challenger	x	x	Certified with M&G	x	Supplied by OEM	x
	Prestige solo	x	x	Certified with M&G	x	Supplied by OEM	x
	Prestige excellence	x	x	Certified with M&G	x	Supplied by OEM	x
Viessmann	Vitodens 100-W WB1B series	x	x	Certified with M&G	x	Supplied by OEM	x
	Vitodens 200-W WB2B series	x	x	Certified with M&G	x	Supplied by OEM	x
Weil McLain	Ultra	x	x	Certified with M&G	x		
OEM waterheater	Model			Status	PolyPro		
Eternal	GU145s	x	x	Certified with Polypro	x		
Navian	NR-180/210/240 NP-180/210/240	x		Certified with Polypro	x		



'LEED' and USGBC logo is a trademark owned by the U.S. Green Building Council and is used by permission.



800-835-4429

Fax: 707-446-4740

www.duravent.com

DuraVent
Member of  M&G Group

L275 10/2011

©2011 M&G DuraVent, Inc.

PolyPro® is one of M&G DuraVent's GreenVent® line of products.