

Complete, Easy To Read INSTALLATION AND OPERATING INSTRUCTIONS

LUXPRO PSD010BFc

BATTERY POWERED, NON-PROGRAMMABLE DIGITAL HEAT ONLY THERMOSTAT (WITH FAN)

LUX PRODUCTS CORPORATION 52130
Mt. Laurel, New Jersey 08054, USA

WARNING: Use Energizer® or DURACELL® Alkaline Batteries Only. Energizer® is a registered trademark of Eveready Battery Company, Inc. DURACELL® is a registered trademark of The Gillette Company, Inc.

IMPORTANT!

Please read all instructions carefully before beginning installation and save for future reference. Before removing any wiring from your existing thermostat, the wires must be labeled with their terminal designations. Ignore the color of the wires since they may not comply with any standard.

Thank you for your confidence in our product. You should become fully acquainted with this thermostat before installing it for usage. Follow the installation procedures carefully, and one step at a time. This will save you time and minimize the chance of damaging either the thermostat or the systems that it controls. These instructions may contain information beyond that required for your particular installation. Please save these instructions for future reference.

COMPATIBILITY

- The single-stage PSD011BFc thermostat can be used with: most 24 volt, single stage heating systems, with or without a blower fan.
- This thermostat cannot be used to control: cooling systems, heat pumps, 3-wire zone valves, or 120/240 volt (line voltage) systems. Ask your dealer for other LUXPRO thermostats to control those systems.

FEATURES

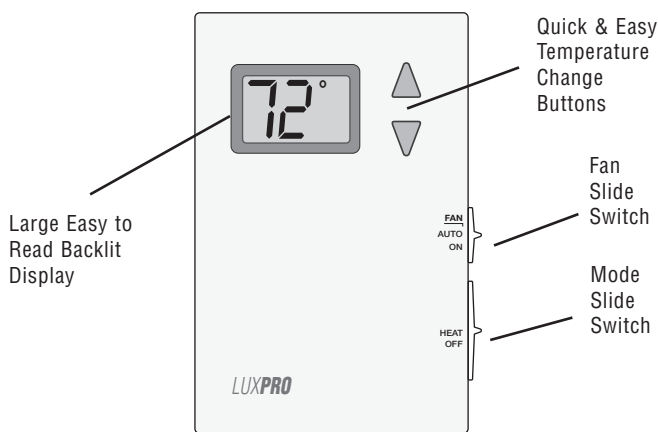

- Digital, Non-Programmable
- Gas / Electric Blower Fan Option
- Battery Powered Only
- Set Temperature Range 40°F to 90°F
- Clean, Attractive Design
- Large, Easy To Read Display with LED Backlight
- Easy To Install
- F / C Selectable Temperature Display
- Fixed 5 Minute Minimum Run / Off Time For Equipment Protection
- Adjustable Temperature Stop

INSTALLATION

PLEASE READ ALL INSTRUCTIONS CAREFULLY BEFORE BEGINNING INSTALLATION.

CAUTION:

This thermostat is protected against normal static electric discharges. However, in extremely dry weather you should touch a grounded metal object before touching the thermostat to minimize the risk of causing damage to the unit.

TOOLS REQUIRED:

- #1 Phillips screwdriver (small - medium)
- Drill with 3/16-in. (4.8mm) drill bit
- Wire stripper/cutter

CAUTION:

Turn off electricity to the appliance before installing or servicing the thermostat or any part of the system. Do not turn the electricity back on until the work is completed.

- Your thermostat is a precision instrument. Please handle it with care.
- Do not short (jumper) across the electric terminals for the furnace to test the system. This may damage the thermostat and void your warranty.
- All wiring must conform to all applicable local codes and ordinances.
- This thermostat should be limited to a maximum of 1.5 amps; higher current may cause damage to the thermostat.

THERMOSTAT LOCATION:

On replacement installations, mount the new thermostat in place of the old one unless the conditions listed below suggest otherwise. On new installations, follow the guidelines listed below.

- Locate the thermostat on an inside wall, at about 5 ft. (1.5m) above the floor, and in a room that is used often.
- Do not install it where there are unusual heating conditions, such as: direct sunlight, near a lamp, television, radiator, register, fireplace, on a wall opposite a stove, or that carries hot water pipes.
- Do not locate in unusual cooling conditions, such as: on a wall separating an unheated room, or in a draft from a stairwell, door, or window.
- Do not locate where air circulation is poor, such as: in a corner or alcove, or behind an open door.
- Do not locate in a damp area. This can lead to corrosion that may shorten thermostat life.
- Do not install the unit until all construction work and painting has been completed.

REMOVING THE OLD THERMOSTAT:

- Switch OFF the electricity to both the furnace and air conditioner; then proceed with the following:
- Remove cover from old thermostat. Most are snap-on types and simply pull off, some have screws on the sides, and these must be loosened first.

- Take note of the letters printed near the wire terminals. Attach labels (enclosed) to each wire for identification by terminal letter, not color.
- Make sure the wires do not fall back inside the wall. Remove and label one wire at a time, and do not allow the wires to touch each other or any parts of the thermostat.
- Loosen all screws on the old thermostat and/or base, and remove it from the wall.

CAUTION:

Be careful not to drop the body or disturb any of the electronic parts.

MOUNTING THE NEW THERMOSTAT:

- Strip insulation leaving 3/8 in. (9.5mm) of bare wire on the ends and clean off any corrosion present.
- Fill the wall opening with non-combustible insulation to prevent drafts from affecting the thermostat while in use.
- Pull your new thermostat apart by applying pressure to the thumb tab on the bottom edge of the unit. While pressure is being applied to this release latch, pull the two halves of the thermostat apart near the bottom edge.

NOTE: If you are mounting the base to a soft material like plasterboard, or if you are using the old mounting holes, the screws may not hold. Drill a 3/16-in (4.8mm) hole at each screw location, and insert the plastic anchors provided. Then mount the base as described below.

- Hold the base against the wall. Route the wires through the larger hole adjacent to the terminal block. Position the base for best appearance (to hide any marks from an old thermostat). Attach the base to the wall with the two screws provided.

CONNECTING THE WIRES:

- Clean bare wire ends must be inserted between the black clamp plate and the brass terminal as shown here.
- Securely tighten all electrical terminal screws (even unused ones).



WIRING INFORMATION

** Complete heating or cooling system wiring can be found in the WIRE IDENTIFICATION AND WIRING SCHEMATICS section of this instruction sheet. The schematics show system components for brand new installations or for un-referenced wires.

SETUP OPTIONS

If batteries are presently installed, remove them from the thermostat before proceeding with changing any of the options listed below.

A table similar to this one shown below is printed on the thermostat's circuit board. There may be minor differences present in some of the wording of your specific model, but the function of each option will be the same.

	UP	DOWN
JP1 (SYS)	FURN	HP
JP2 (SCALE)	F	C
JP3 (FAN)	ELECT	GAS
JP4 (B / O)	B	O

JUMPER SETTINGS:

There are four (4) headers (or jumpers) located inside the thermostat at the rear of the circuit board. These settings can be changed from their default values by removing its corresponding black jumper cap and reinstalling the cap so that it is positioned on the adjacent pair of metal pins. A change to ANY of the option jumper settings will not be recognized unless the thermostat has been without battery power for at least 2 minutes, and then power is restored again. Each of these jumpers changes a different setup option. The choices for these options are listed in a table printed on the circuit board, and are also printed adjacent to each individual setting jumper.

JP1 - FURNACE / HEAT PUMP SYSTEM TYPE:

This setting is not used on this PSD010BFc model.

JP2 - FAHRENHEIT OR CELSIUS DISPLAY FORMAT:

This setting controls whether the temperature is shown in degrees °F or °C on the LCD display screen.

JP3 - HEAT FAN CONTROL:

This setting defines the fan operation while in Heat mode, and when the fan is in Auto.

GAS: Use this setting if you have a Gas or Oil heating system. In the GAS setting, the heating system itself controls the operation of the blower fan (if equipped).

ELECTRIC: Use this setting if you have a Heat Pump or Electric heating system. In the ELEC setting, the heating system requires the thermostat to control the operation of the blower fan.

JP4 - [B] OR [O] TERMINAL USAGE OPTION:

This setting is not used on this PSD010BFc model.

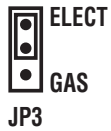
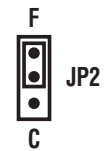

COMPLETING THE INSTALLATION

Once all optional jumper settings have been performed as described in the previous section, please ensure that the thermostat has been without battery power for at least 2 minutes. Now install new batteries into the thermostat. When installing batteries, use two new Energizer® or DURACELL® "AA" size alkaline batteries only. Ensure that the batteries are installed in the proper direction as per the markings shown in the battery tray.

Install your new thermostat onto its base. To do this, start with the bottom tilted out towards you at first, and line up the two holes in the top of the thermostat with the two hooks on the top of the back plate. Slowly pivot the bottom of the thermostat towards the back plate and push firmly on the bottom half of the thermostat until it is securely latched to the back plate. If the two thermostat halves do not latch easily, remove and try again. Do not attempt to force them together.

NOTE: Before use, remove the plastic film (if present) that is protecting the LCD display screen.

Turn the electrical power back ON to both your heating and/or air conditioning systems. Verify that both systems (and the blower fan if used) are operating properly. When set to a high temperature, the heating system should provide warm air after a short time in Heat Mode. Likewise, a cooling system should provide cool air after a short time when set to a low temperature in Cool Mode. Usually, sound from the furnace and/or air conditioning units can be heard while either is running. If your system uses a blower fan, the rush of moving air should be heard within a short time after either has been started. Your installation is now complete.

FRONT PANEL ITEMS

SYSTEM MODE SWITCH:

The MODE switch has two positions: HEAT and OFF. In the winter, set the mode switch to HEAT to control your heating system. In the spring and fall, or when the windows are open, you can set the switch to OFF.

NOTE: When the system mode switch is in the OFF position, it is normal for the system's blower fan ("G" terminal if used) to still become activated depending upon the position of the FAN mode switch (see below).

FAN MODE SWITCH:

The FAN switch has two positions: AUTO and ON.

- In the AUTO position, the operation of the blower fan is determined only by the on/off cycling of the heating system.
- When the FAN switch is in the ON position, the system's blower fan will be commanded ON, and remain ON while the FAN switch is in the ON position (this also includes when the System Mode Switch is in the OFF position).

NOTE: The FAN switch only works if your system provides a wire for the thermostat's "G" terminal.

PUSH BUTTONS:

There are two push buttons to the right of the unit's display screen. These are used to adjust the set point temperature.

OPERATING INSTRUCTIONS

TEMPERATURE ADJUSTMENT:

While in HEAT mode, a single press on either the UP or DOWN button causes the word "SET" to appear on the screen. Once "SET" is present, the set temperature value starts flashing and the set point temperature can be altered by pressing either the UP or DOWN button once per degree of change, or by holding either button for at least two seconds to automatically increment the set point quickly in the associated direction.

Based upon the relationship of the set temperature to the displayed ambient room temperature, the thermostat will engage the W1 terminal in heat mode, if a temperature demand is present.

DISPLAY ILLUMINATION:

Pressing either set temperature button will illuminate the display for easier viewing in dim light conditions. The light will remain on for approximately 12 seconds. While the light is illuminated, pressing any of the three push buttons will continue the lighting and remain on for approximately 12 more seconds.

MINIMUM RUN/OFF TIME:

This is determined by the thermostat, and controls the minimum length of time that the thermostat must remain with Heat either On or Off, before it will automatically switch to the alternate On or Off state. This feature prevents rapid or short cycling of the heating equipment. The time amount for this delay is fixed at 5 minutes between on or off load changes.

ADJUSTABLE TEMPERATURE STOP:

This model has an Adjustable Temperature Stop. This is a set temperature limit, and is user adjustable in one-degree increments. The temperature stop prevents the set temperature from being adjusted to a value that is higher than the temperature stop setting.

To adjust the temperature stop, always start with the system mode switch in the OFF position. Press and hold the UP key while sliding the mode switch from OFF to HEAT. "Ht Lim" will be displayed on the LCD screen while in the adjustment mode. Use the UP and DOWN buttons to adjust the desired limit value, just as you would for adjusting the set temperature under normal operation. NOTE: If no buttons are pressed for 4 seconds, the thermostat will accept the value on the screen at that time and return to normal operation. Once the temperature stop is set, you should return to the adjustment mode to confirm that your desired setting was accepted.

BATTERIES AND MAINTENANCE

The batteries in the thermostat should be replaced AT LEAST once per year, or sooner if the "LO BAT" battery symbol appears in the lower right portion of the display screen.

To replace the batteries in the thermostat, remove the thermostat's body from the wiring base plate attached to the wall by pressing the thumb latch at the bottom center of the unit and swinging the front body out towards you, up and away from the base. Remove the used batteries from the battery tray and discard appropriately.

Install two new Energizer® or DURACELL®, "AA" size Alkaline batteries into the battery tray. Observe the polarity markings shown in the battery compartment to ensure proper installation. When finished, hang the top of the unit by the tabs at the top corners of the base, and then snap the bottom of the unit into place. Do not use unnecessary force. If the body does not snap into place easily, remove the body, re-hang it from the tabs at the top and try again.

TECHNICAL ASSISTANCE

If you have any problems installing or using this thermostat, please carefully and thoroughly review the instruction manual. If you require assistance, please contact our Technical Assistance Department at 856-234-8803 during regular business hours between 8:00AM and 4:30PM Eastern Standard Time, Monday through Friday. You can also receive technical assistance online anytime day or night at <http://www.luxproproducts.com>. Our web site offers you answers to the most common technical questions, and also permits you to email your questions to our technical support staff at your convenience.

WARRANTY

Limited Warranty: If this unit fails because of defects in materials or workmanship within three years of the date of original purchase, LUX will, at its option, repair or replace it. This warranty does not cover damage by accident, misuse, or failure to follow installation instructions. Implied warranties are limited in duration to three years from the date of original purchase. Some states do not allow limitations on how long an implied warranty lasts, so the above limitation may not apply to you. Please return malfunctioning or defective units to the location from which the purchase was made, along with proof of purchase. Please refer to "Technical ASSISTANCE" before returning thermostat. Purchaser assumes all risks and liability for incidental and consequential damage resulting from installation and use of this unit. Some states do not allow the exclusion of incidental or consequential damages, so the above exclusion may not apply to you. This warranty gives you specific legal rights and you may also have other rights which vary from state to state. Applicable in the U.S.A. and Canada only.

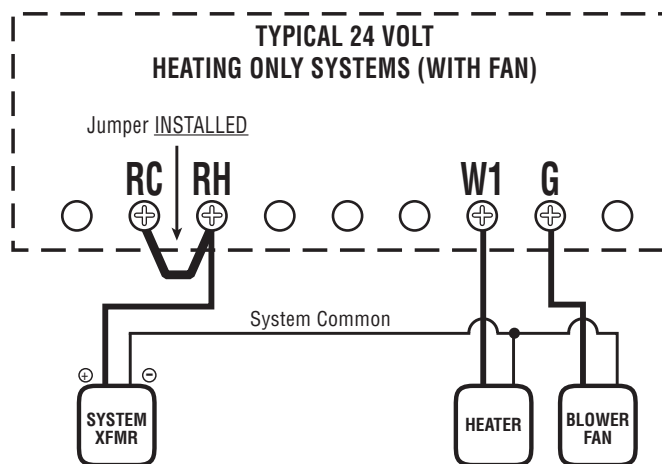
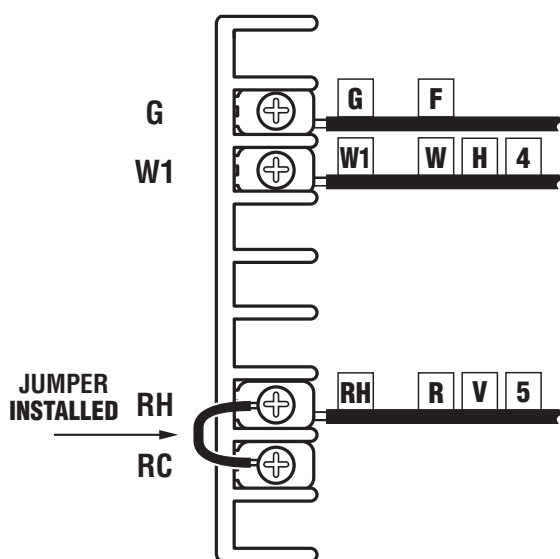
(PSD010BFc) ENGLISH - WIRE IDENTIFICATION AND WIRING SCHEMATICS**HEATING ONLY SYSTEMS
(WITH FAN)****WIRING DIAGRAM NOTES:**

1. The **BOLD** lines are what you should be connecting to the terminals on this new thermostat.
2. In many cases, the thin lines shown as "SYSTEM COMMON" will not be visible at the thermostat location, they are located with your heating and cooling equipment.

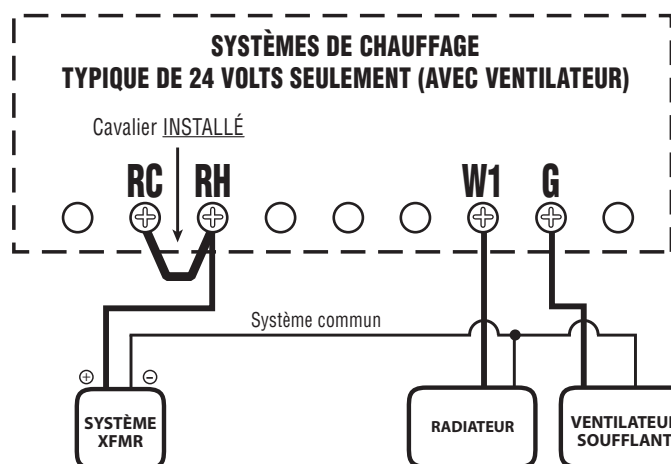
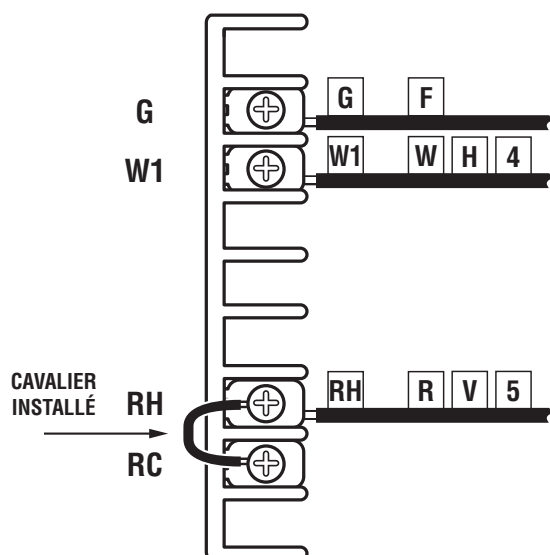
(PSD010BFc) FRANÇAIS – IDENTIFICATION DES FILS ET SCHÉMAS DE CÂBLAGE**SYSTÈMES DE CHAUFFAGE SEULEMENT
(AVEC VENTILATEUR)****REMARQUES AU SUJET DES SCHÉMAS DE BRANCHEMENT :**

1. Les lignes en **GRAS** représentent les fils que vous devriez connecter aux bornes de ce nouveau thermostat.
2. Dans de nombreux cas, les lignes minces marquées « **SYSTÈME COMMUN** » ne seront pas visibles où le thermostat se trouve, car elles se trouvent avec les appareils de chauffage et de climatisation.

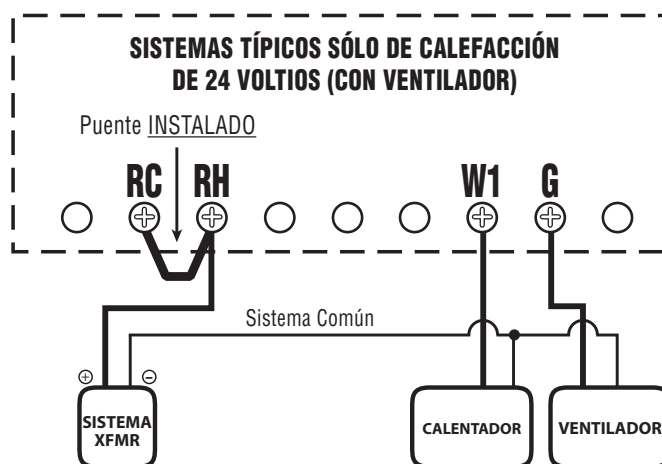
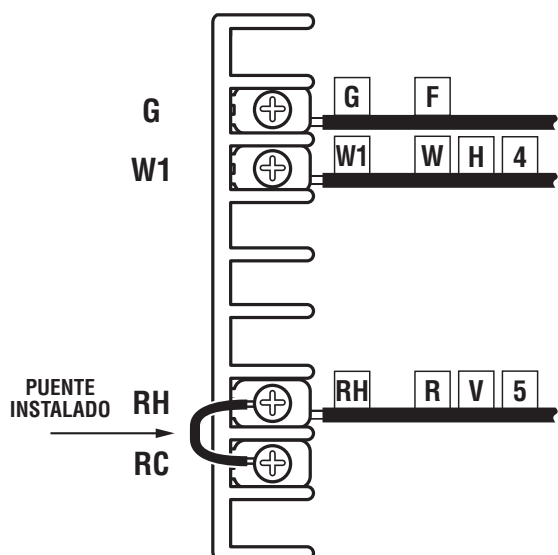
(PSD010BFc) ESPAÑOL – IDENTIFICACION DE CABLES Y DIAGRAMAS DE CABLEADO**SISTEMAS SÓLO DE CALEFACCIÓN
(CON VENTILADOR)****COMENTARIOS SOBRE LOS DIAGRAMAS DE CABLEADO:**

1. Las líneas **RESALTADAS** son las que debe conectar a los terminales de este nuevo termostato.
2. En muchos casos, las líneas delgadas, que se indican como "SISTEMA COMUN", no se pueden ver en el termostato porque se encuentran en su equipo de calefacción y refrigeración.